

ST008

- Adjustable seat height
- Optional drafting kit
- Optional glides or brake castors
- 600mm Black nylon base
- Available in black only
- 5 Year warranty
- Weight limit is 120kg

SKU: ST008



GALLERY IMAGES

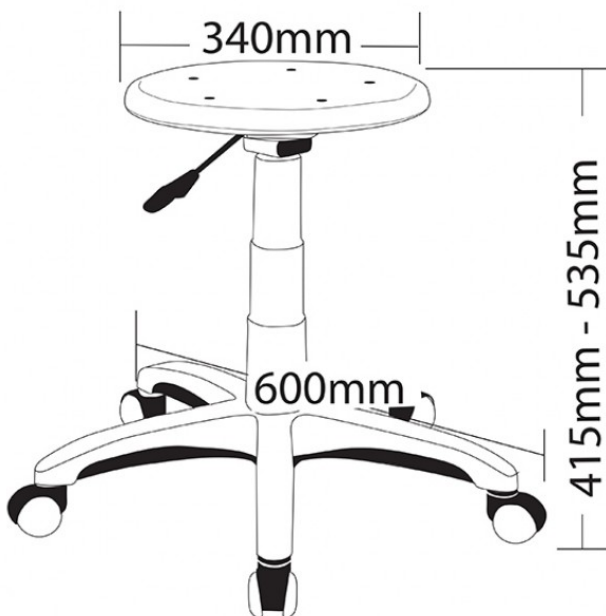



Q Office Furniture
02 63 62 3530
enquiries@qof.com.au
www.qof.com.au